



distinta

- 1 cassonetto completo
- 2 guide
- 1 profilo battuta
- 1 coppia zoccoli fissi

- 4 perni aggancio completo
- 4 copriforo normale
- 4 copriforo con spondina
- 4 viti STEI M5X6 a punta UNI5927

- 1 chiave esagonale 2,5 mm
- 1 spazzolino grigio

Preassemblare i grani delle testate del cassonetto avvitandoli per qualche mm.



01

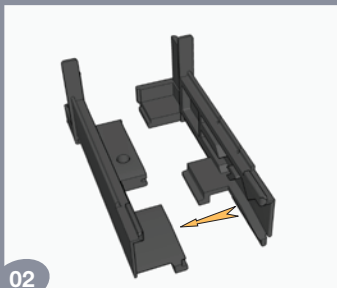

02

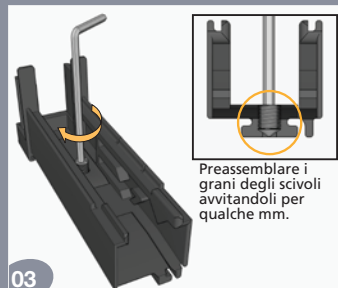

03

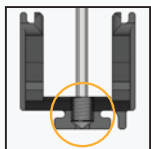

Preassemblare i grani degli scivoli avvitandoli per qualche mm.

Scegliere la posizione dei ganci secondo le proprie esigenze e tagliare gli spazzolini rispettando la formula:

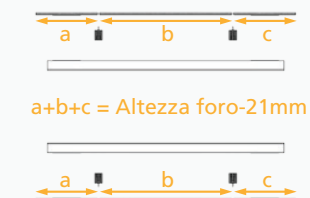

04

Inserire i ganci inferiori fino all'altezza calcolata

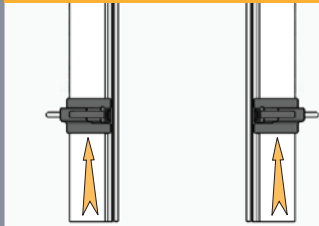

05

Inserire gli spazzolini (b) e i ganci superiori.

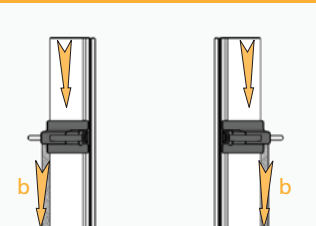

06

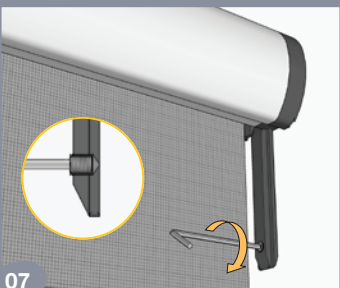

07

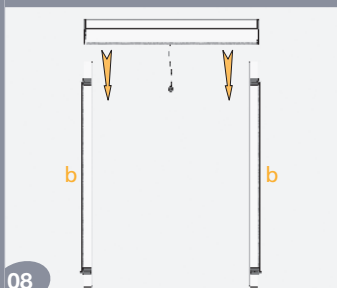

08

Tagliare lo spazzolino superiore rispettando la formula:
 $L = \text{Base foro} - 6\text{mm}$

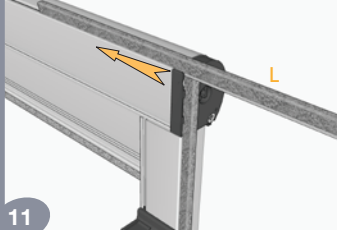

11

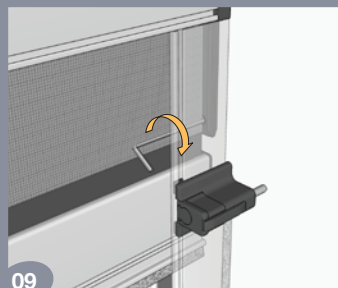

09

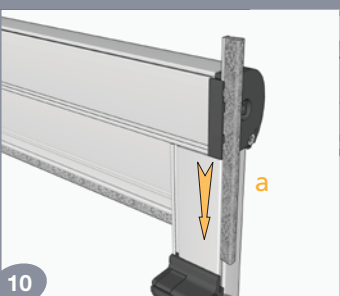

10



12

L'azienda si riserva di apportare modifiche senza preavviso.

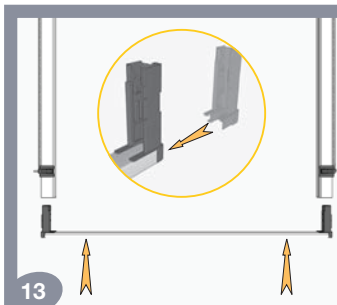

13

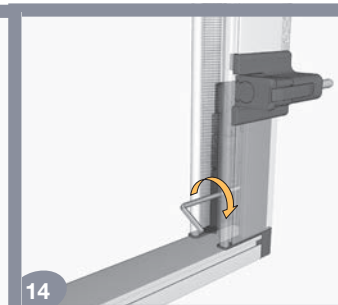

14

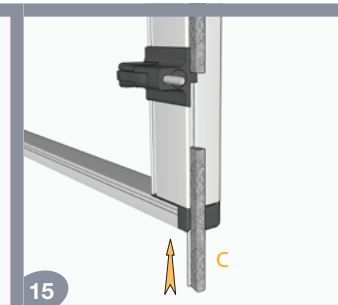

15



16

Tagliare lo spazzolino inferiore rispettando la formula:

$L = \text{Base foro} - 6\text{mm}$

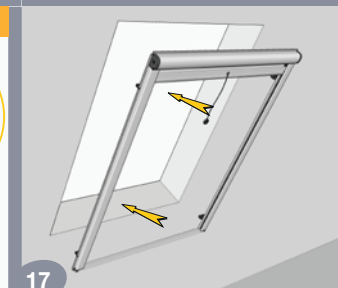

17

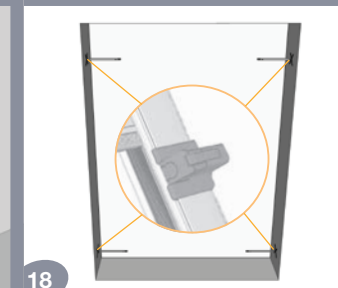

18



19

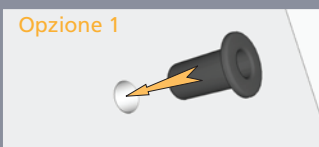

Opzione 1



Opzione 2

Aprire i ganci tirando la parte mobile e bloccarli agendo sulla leva superiore.

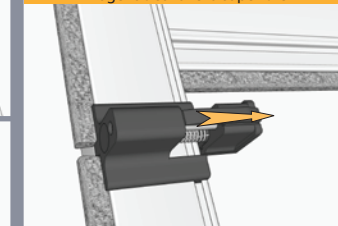

21

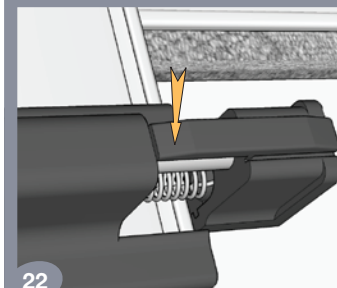

22

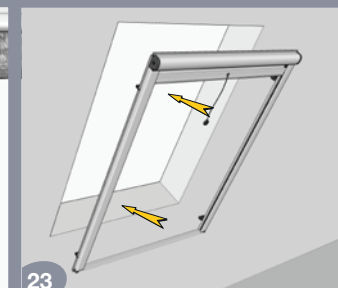

23

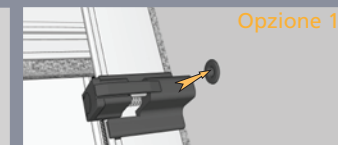

Opzione 1

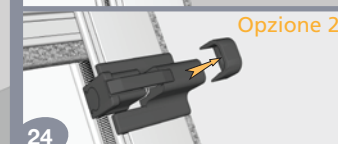

Opzione 2

24

Sbloccare i ganci agendo sulla parte posteriore della leva



25

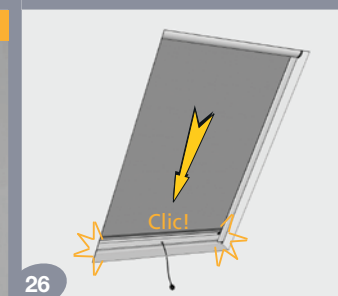

26

